

TOMA DE AGUA
WASH DOWN FITTING
INGRESSO ACQUA

Toma de agua para la manguera de baldeo. Rosca exterior standard de jardineria.

Standard garden hose threads.

Ingresso acqua per lavaggio. Filetto esterno standard

REF				
THWDV-1CP	3/4" = 19 mm	2 1/4" = 57 mm	1	



Toma de agua dulce para cubierta. Fabricado en acero inox AISI-316.

Water inlet for water at dockside. Made of 316 cast stainless steel.

Ingresso acqua dolce. In acciaio inox AISI-316.

REF		
GS30357	2 3/4" = 70 mm	1



INODORO ELÉCTRICO • ELECTRIC TOILET • WC ELETTRICO

INODORO ELÉCTRICO
ELECTRIC TOILET
WC ELETTRICO

Fabricado en porcelana vitrificada, con tapa de plástico blanco. Completo con interruptor.

White porcelain bowl, with plastic seat and cover. Switch box included.

In porcellana vetrificata, con coperchio in plastica bianca. Con interruttore.

REF							
GS50010	12 V	352 mm	360 mm	445 mm	11 kg	3/4"	1"
GS50011	24 V	352 mm	360 mm	445 mm	11 kg	3/4"	1"

LUX

REF							
GS50012	12 V	460 mm	383 mm	480 mm	21 kg	3/4"	1"
GS50013	24 V	460 mm	383 mm	480 mm	21 kg	3/4"	1"



KIT ELÉCTRICO
ELECTRIC KIT
KIT ELETTRICO

Base y motor con bomba maceradora, para inodoros.

Base and electric pump for marine toilets.

Base e motore con pompa maceratrice.

REF					
GS50015	12 V 18A	25A	1"	1"	1
GS50016	24 V 9A	15A	1"	1"	1

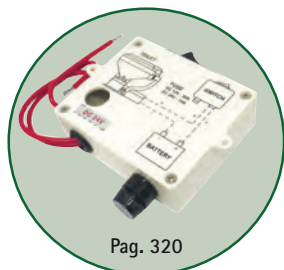

Pag. 320



HABITABILIDAD • HABITABILITY • HABITABILITÀ



Tazón de cerámica, asiento de madera con acabado de esmalte al horno

Ceramic bowl, wood seat with baked enamel finish

Ciotola in ceramica, sedile in legno con finitura smaltata al forno

new

REF	⚡	↕	↔	↗	KG	⚙️	⚙️
SFMT101	12 V	350 mm	330 mm	468 mm	11 kg	3/4"	1"
SFMT201	24 V	350 mm	330 mm	468 mm	11 kg	3/4"	1"

SEAFLO

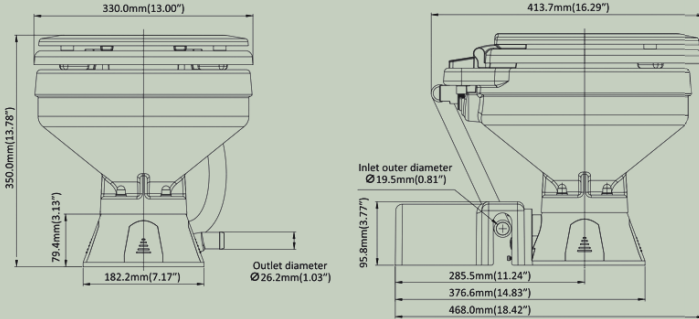

BOMBA
PUMP
POMPE

REF	⚡
SFMT101	12 V
SFMT201	24 V



Tazón de cerámica, asiento de madera con acabado de esmalte al horno

Ceramic bowl, wood seat with baked enamel finish

Ciotola in ceramica, sedile in legno con finitura smaltata al forno

new

REF	⚡	↕	↔	↗	KG	⚙️	⚙️
SFTME102	12 V	323 mm	330 mm	415 mm	11,5 kg	3/4"	1 1/2"
SFTME202	24 V	323 mm	330 mm	415 mm	11,5 kg	3/4"	1 1/2"

SEAFLO

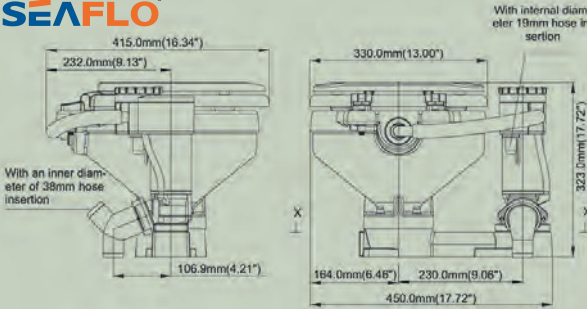

KIT CONVERSIÓN ELÉCTRICO
ELECTRIC CONVERSION KIT
KIT DI CONVERSIONE ELETTRICA

REF	⚡
SFMT102	12 V
SFMT202	24 V

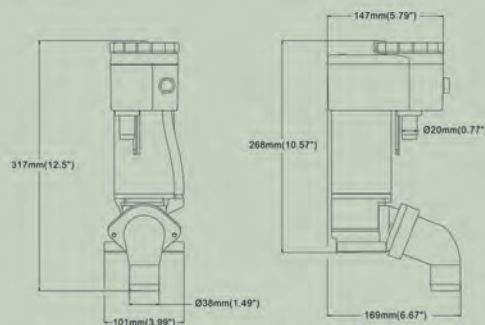

HABITABILIDAD • HABITABILITY • HABITABILITÀ • HABITABILITÀ

RECAMBIOS MARINOS

INODORO MANUAL • MANUAL TOILET • WC MARINO MANUALE

Tazón de cerámica, asiento de madera con acabado de esmalte al horno
 Ceramic bowl, wood seat with baked enamel finish
 Ciotola in ceramica, sedile in legno con finitura smaltata al forno

REF

SFMTM01 331,5 mm 330 mm 415 mm 9,6 kg 3/4" 1 1/2"

SEAFLO

X-X SECTION VIEW
(display base mounting hole)

With an internal diameter of 19mm hose insertion

With an internal diameter of 38mm hose insertion

**BOMBA MANUAL
 MANUAL PUMP
 POMPA MANUALE**

REF
 SFMTP03

new

INODORO MANUAL
 MANUAL TOILET
 WC MARINO MANUALE

Fabricado en porcelana vitrificada, con tapa de plástico blanco.
 White porcelain bowl, with plastic seat and cover.
 In porcellana vetrificata, con coperchio in plastica bianca.

REF

GS50001 330 mm 473 mm 416 mm 9,5 kg 3/4" 1 1/2"

GOLDENSHIP

**BOMBA MANUAL
 MANUAL PUMP
 POMPA MANUALE**

REF
 GS50008 1

**KIT DE SERVICIO
 SERVICE KIT
 KIT POMPA MANUALE**

REF
 GS50022 1

GOLDENSHIP

INODORO QUÍMICO • PORTABLE TOILET • WC CHIMICI

INODORO QUÍMICO PORTABLE TOILET WC CHIMICO

Inodoro portátil con depósito hermético. Asiento y tapa desmontable para facilitar la limpieza. Con bomba de pistón para limpiar la taza. Color blanco. Con indicador de nivel y kit de anclaje





Portable marine toilet with sealed valve that keeps odor in holding tank. Piston pump flushing fresh water to clean bowl. With level indicator and hold down kit.

WC chimico portatile con deposito ermetico. Tavoletta e coperchio smontabili per facilitarne la pulizia. Con pompa pistone per pulire la tazza. Colore bianco. Con indicatore di livello.

Inodoro portátil con depósito hermético. Asiento y tapa desmontable para facilitar la limpieza. Con bomba de fuelle para limpiar la taza. Color blanco.

Portable marine toilet with sealed valve that keeps odor in holding tank. Bellorw pump flushing fresh water to clean bowl.

WC chimico portatile con deposito ermetico. Tavoletta e coperchio smontabili per facilitarne la pulizia. Con pompa a soffiato per pulire la tazza. Colore bianco.

REF				
TF335	10 L	313 mm	342 mm	382 mm
TF365	21 L	414 mm	383 mm	427 mm





THETFORD



TF335



TF365

REF				
TF145	12 L	330 mm	383 mm	422 mm
TF165	21 L	414 mm	383 mm	427 mm

THETFORD



TF145



TF165

ACCESORIOS • ACCESSORIES • ACCESSORI

KIT INDICADOR DE NIVEL WASTE LEVEL INDICATOR KIT INDICATORE LIVELLO

Para depósitos de aguas negras. Se compone de un transmisor con varillas de acero inox y panel de control con 4 niveles e indicador de «Full». Sonda máxima: 25 cm. Con certificación CE.

Warning panel waste tank level with pre-wired sender. With 4 leds + full led indicators. Max.depth: 25 cm. CE certification.

Kit indicatore livello, per depositi acque nere. Trasmettitore con aste in acciaio inox e pannello di controllo con 4 livelli e indicatore "Full". Sonda massima 25cm. Certificazione CE.

REF			
GS50038	12V	87 x 75 mm	1

GOLDENSHIP

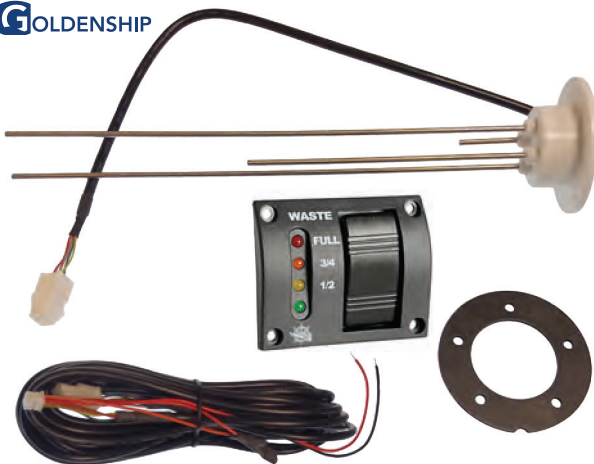



INTERRUPTOR INODORO TOILET SWITCH INTERRUTTORE WC

Hasta 15 A. Con retorno automático y magnetotérmico incorporado.



15A. Watertight, automatic return toggle and built-in magnetotermic fuse

Fino a 15A. Con ritorno automatico e magnetotermico incorporato.

REF			
GS50017	12/24V	80 x 60 mm	1

GOLDENSHIP



REF		
GS50018	12V 30A	1
GS50019	24V 15A	1

GOLDENSHIP

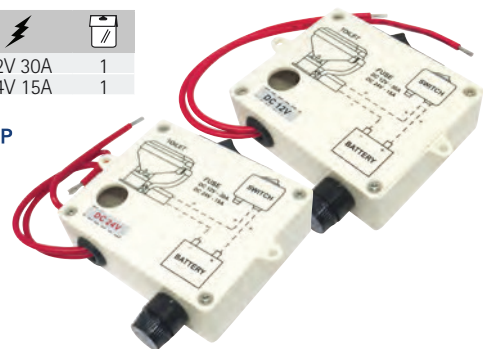

PAPEL ESPECIAL INODORO
TOILET TISSUE
CARTA INODORE

Rápida disolución. Ayuda a prevenir los atascos. 4 rollos de 2 capas. Biodegradable.

Prevents clogging by rapidly dissolving in holding tanks. 2 ply. Biodegradable

Rapida dissolvenza. 4 rotoli di circa 2 strati. Biodegradabile.



REF	
TF41235	AQUA SOFT



FILTRO DE CARBON ACTIVO
TANK VENT FILTER
FILTRO DI CARBONE ATTIVO

Intercalar en la manguera de ventilación del depósito de aguas negras. Elimina los malos olores. Fabricado en aluminio y nylon con terminales para manguera de 20 - 25 mm.

lit removes bad odours. Made of aluminium and nylon. Fitted with rubber coated stainless steel straps for bulkhead mounting. With female hose adaptors 1/2".

Mettere nel tubo di ventilazione del deposito delle acque nere. Elimina i cattivi odori. In alluminio e nylon con terminali per tubi de 20-25mm.

REF			
GS50037	250 x Ø 50 mm	1	



DESODORANTE PARA LA TAZA
DEODORANT AND CONDITIONER
DEODORANTE PER LA TAZZA

Desodorante perfumado, para la limpieza y protección de la taza. Se mezcla en el depósito de agua limpia.

Deodorant and conditioner. Cleans and freshens toilets.

Deodorante profumato, per la pulizia e la protezione della tazza.

REF		
TF41232	AQUA RINSE	1,5 L



DESODORANTES PARA DEPÓSITOS
HOLDING TANK DEODORANT
DEODORANTE PER LE ACQUE NERE

REF		
TF41228	AQUA-KERN BLUE	1 L
TF41234	AQUA-KERN BLUE	2 L
TF30262	AQUA-KERN SACHETS	15 x 30g



DETERGENTE PARA DEPÓSITOS
TANK CLEANER
DETERGENTE PER DEPOSITO ACQUE NERE

Detegente desarrollado para el mantenimiento del depósito de aguas negras.

Specially made for waste holding tanks periodical maintenance.

Detegente per il mantenimento periodico del deposito di acque nere.

REF		
TF41239	TANK CLEANER	1 L
TF30272	TANK FRESHENER	1 L



DESODORANTE DEPÓSITOS BIODEGRADABLE
HOLDING TANK DEODORANT BIODEGRADABLE
DEODORANTE PER LE ACQUE NERE BIODEGRADABILE

REF		
TF41233	AQUA-KERN GREEN	1,5 L
TF20536	AQUA-KERN SACHETS	10 x 55g



HABITABILIDAD • HABITABILITY • HABITABILITÀ

