

TURBOS - Turbos

MODELO MOTOR <i>Engine model</i>	MOD.TURBO <i>Turbo mod.</i>	R.O. <i>Oem</i>	REFERENCIA <i>Reference</i>
4LH-HTE, 4LH-TE	MY58	119171-18010	REC119171-18010
4LH-HTE	MYBF	119172-18011	REC119172-18011
4LH-DTE	53269886292	119173-18011	REC119173-18011
4JH-TE	MY29	129497-18000	REC129497-18000
4JH3-T	MYCZ	129671-18001	REC129671-18001
4JH-DTE	MY34	129473-18000	REC129473-18000
4LH-STE	MYAV	119195-18031	REC119195-18031
4LHA-STP, 4LHA-STE	MYDA	119175-18031	REC119175-18031
4LHA-DTZE, 4LHA-DTE 4LHA-DTP	MYDH	119173-18041	REC119173-18041
4LHA-HTE	MYDN	119172-18030	REC119172-18030



CODOS DE ESCAPE - Exhaust elbows

SED3092400

CODO ESCAPE INOX
S.S.Exhaust Elbow
140HP 4 LHDTE, 6YL
R.O.: 119173-13501



HGE3520

CODO ESCAPE HIERRO
Iron Exhaust Elbow
1GM, 2GM, 3GM, 1GM10,
2GM10, 3GM30, 3HM, 3HM35F
R.O.: 124070-13520



SED3092401

CODO ESCAPE INOX
S.S.Exhaust Elbow
YANMAR 6LPSTE - 6LPDTE
(260-315 HP)
R.O.: 119773-49110



MOTORES DE ARRANQUE y ALTERNADORES - Starters & alternators

PH150-0004

MOTOR DE ARRANQUE
15 dientes piñon bendix
3HM, 3JH, 4JH.
Starter 15 teeth bendix
R.O.: 124250-77012
129573-77010
171008-77010



REC123500-77010

MOTOR DE ARRANQUE
11 dientes piñon bendix
6T95L, 6LY, 3T95L
4PH, 4T95L, 4T112, 6PH
Starter 11 teeth bendix
R.O.: 123500-77010
124610-77010



PH140-0008

MOTOR DE ARRANQUE
Starter
GM, GM2, GM3, GM10
GM20, GM30, GMF
1GM, 2GM, 3GM
R.O.: 128170-77010



PH300-0020

ALTERNADOR 12V-40 Amp.
Regulador interno y polea
simple de serpiente.
Alternator 12V 40A.
Internal regulator with
single serpentine pulley.
R.O.: 119836-77200
119836-77201



PH140-0007

MOTOR DE ARRANQUE
CONTRARROTACION
CCW Starter
L40S, L60S
R.O.: 114362-77011



PH300-0005

ALTERNADOR 12V 35A
Alternator 12V 35A
1GM, 2GM, 3GM, 3HM
R.O.: 128270-77200



PH140-0009

MOTOR DE ARRANQUE
Starter
4JH, QM20, 2QM20, 2T
R.O.: 129698-77010



PH300-0002

ALTERNADOR 12V 80A
Alternator 12V 80A
3JH, 4JH, 6LY, 4LH, 6CX
R.O.: 119573-77200, -77201



PH150-0005

MOTOR DE ARRANQUE
Starter
6LP-DTE, 6LP-STE
R.O.: 119773-77010



PH300-0018

ALTERNADOR 12V-80 Amp.
Regulador interno y polea doble.
Alternator 12V 80A.
Internal regulator with
double pulley.
R.O.: 119773-77200









REC121254-77012





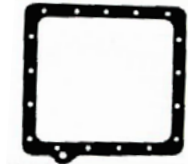















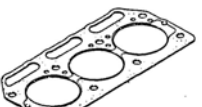

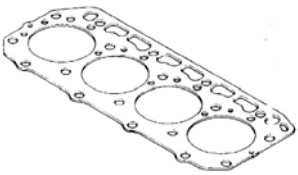
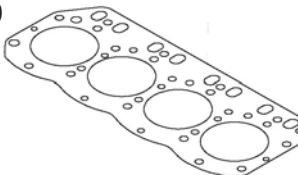
MOTOR DE ARRANQUE
15 dientes piñon bendix
4LHA, DTE, DTZ, HTE, HTZE,
STE, STZE.
4LH, DTE, HTE, STE, TE
Starter 15 teeth bendix
R.O.: 121254-77010, -11, -12, -19.
129429-77010, -11.
171058-77010.
YM129429-77010.



JUNTAS - Gaskets

REC128170-11310 JUNTA BALANCINES <i>Rocker cover gasket</i> R.O.128170-11310	
REC128270-11310 JUNTA BALANCINES <i>Rocker cover gasket</i> R.O.128270-11310	
REC104211-49160 JUNTA ESCAPE <i>Exhaust gasket</i> R.O.104211-49160	
REC128170-03070 JUNTA ESCAPE <i>Exhaust gasket</i> R.O.128170-03070	
REC128170-42090 JUNTA BOMBA AGUA <i>Water pump gasket</i> R.O.128170-42090	
REC124000-01751 JUNTA CARTER <i>Gasket carter</i> R.O.124000-01751	
REC121000-01751 JUNTA CARTER <i>Gasket carter</i> R.O.121000-01751	
REC128170-32030 JUNTA BOMBA ACEITE <i>Oil pump gasket</i> R.O.128170-32030	

JUNTAS CULATA y KITS - Head cylinder Gasket & kits

<p>REC128170-01331 R.O.:128170-01331</p> 	<p>REC128171-01911 R.O.:128171-01911</p> 	<p>REC128271-01911 R.O.:128271-01911</p> 	<p>REC128374-01911 R.O.:128374-01911</p> 	
<p>REC129171-01330 R.O.:129171-01330</p> 	<p>REC129002-01331 R.O.:129002-01331</p> 	<p>REC129553-01350 R.O.:129553-01350</p> 	<p>REC129573-01351 R.O.:129573-01351</p> 	<p>REC119174-01340 R.O.:119174-01340</p> 
<p>REC128370-01332 R.O.:128370-01332</p> 	<p>REC121575-01334 R.O.:121575-01334</p> 	<p>REC128671-01330 R.O.:128671-01330</p> 	<p>REC129001-01340 R.O.:129001-01340</p> 	<p>REC129408-01330 R.O.:129408-01330</p> 
<p>REC129693-01331 R.O.:129693-01331</p> 	<p>REC129407-01340 R.O.:129407-01340</p> 			
<p>REC728170-92600 R.O.: 728170-92600</p> 	<p>REC728171-92601 R.O.: 728171-92601</p> 	<p>REC728271-92605 R.O.:728271-92605</p> 		
<p>REC728374-92605 R.O.: 728374-92605</p> 	<p>REC729171-92600 R.O.: 729171-92600</p> 	<p>REC729270-92601 R.O.:729270-92601</p> 		
<p>REC729470-92605 R.O.: 729470-92605</p> 	<p>REC729573-92605 R.O.: 729573-92605</p> 	<p>REC719171-92602 R.O.: 719171-92602</p> 	<p>REC719173-92600 R.O.: 719173-92600</p> 	

GUIA JUNTAS CULATA y KITS JUNTAS
Head cylinder Gaskets & Gaskets sets Guide

MODELO <i>Model</i>	Nº DE CILINDROS <i>Number of cylinders</i>	REF. JUNTAS DE CULATA <i>Ref. head cyl. gasket</i>	REF. KIT JUNTAS <i>Ref. gaskets sets</i>
1GM	1	REC128170-01331	REC728170-92600
1GM10	1	REC128171-01911	REC728171-92601
2GM20	2	REC128271-01911	REC728271-92605
2GM20F	2	REC128271-01911	REC728271-92605
2GM15	2	REC124060-01331	REC728271-92605
3GM30	3	REC128374-01911	REC728374-92605
3GM30(EU)	3	REC128374-01911	REC728374-92605
3GM30F	3	REC128374-01911	REC728374-92605
3GM30F(EU)	3	REC128374-01911	REC728374-92605
3GMD	3	REC128370-01332	N/A
3HM	3	REC121575-01334	N/A
3HM35	3	REC128671-01330	N/A
3JH2E	3	REC129171-01330	REC729171-92600
3JH2TE	3	REC129171-01330	REC729171-92600
3JH3EYEU	3	REC129002-01331	REC729270-92601
3JHH-E	3	REC129001-01340	N/A
4JHE	4	REC129553-01350	REC729470-92605
4JHTE	4	REC129553-01350	REC729470-92605
4JHDTE	4	REC129553-01350	REC729470-92605
4JH2E	4	REC129573-01351	REC729573-92605
4JH2TE	4	REC129573-01351	REC729573-92605
4JH2HTE	4	REC129573-01351	REC729573-92605
4JH2DTE	4	REC129573-01351	REC729573-92605
4JH2UTE	4	REC129573-01351	REC729573-92605
4JH3E-YEU	4	REC129408-01330	N/A
4JH3-TCE	4	REC129693-01331	N/A
4JH4E	4	REC129407-01340	N/A
4LHTE	4	REC119174-01340	REC719171-92602
4LHHTE	4	REC119174-01340	REC719171-92602
4LHDTE	4	REC119174-01340	REC719171-92602
4LHSTE	4	REC119174-01340	REC719171-92602
4LHAHTE	4	N/A	REC719173-92600
4LHADTE	4	REC119174-01340	REC719173-92600
4LHASTE	4	REC119174-01340	REC719173-92600

JUEGOS DE AROS PARA PISTONES - Piston ring kits

MODELO MOTOR <i>Engine model</i>	R.O. <i>Oem</i>	REFERENCIA <i>Reference</i>
1GM10-20-30 2GM20C 2GM20F 3GM30	Std. 721575-22500	REC721575-22500
1/2/3/GM	Std. 721000-22500	REC721000-22500
YSM12	Std. 704571-22500	REC704571-22500







VALVULAS ADMISIÓN Y ESCAPE - Intake & Exhaust valves

MODELO MOTOR <i>Engine model</i>	R.O. <i>Oem</i>	REFERENCIA <i>Reference</i>
YSM8/YSB8/3HM35 Valvula admisión - <i>Intake valve</i> Valvula escape - <i>Exhaust valve</i>	104211-11100 104211-11110	REC104211-11100 REC104211-11110
YSM12/YSB12/YSE12 Valvula admisión - <i>Intake valve</i> Valvula escape - <i>Exhaust valve</i>	104511-11100 104511-11110	REC104511-11100 REC104511-11110
1-2-3GM/2GM20F/1GM10/2GM20 Valvula admisión - <i>Intake valve</i> Valvula escape - <i>Exhaust valve</i>	105225-11100 105225-11110	REC105225-11100 REC105225-11110







GUIA MANTENIMIENTO - *Guide Maintenance*

					
MODELO <i>Model</i>	FILTRO DE ACEITE <i>Oil Filter</i>	FILTRO COMBUSTIBLE <i>Fuel filter</i>	FILTRO DE AIRE <i>Air Filter</i>	ANODO ZINC <i>Zinc Anode</i>	IMPULSOR <i>W.P. Impeller</i>
1GM	REC119305-35151 119305-35151	REC104500-55710 104500-55710	REC128170-12540 128170-12540	TEN01303 27210-200200	CEF500113 128176-42071
2GM/3GM	REC119305-35151 119305-35151	REC104500-55710 104500-55710	128270-12540	CMC272100-200300 27210-200300	CEF500100GX 104211-42070
2GMF/3GMF	REC119305-35151 119305-35151	REC104500-55710 104500-55710	128270-12540	CMC272100-200300 27210-200300	CEF500129 128296-42070
1GM10	REC119305-35151 119305-35151	REC104500-55710 14500-55710	128171-12540	TEN01303 27210-200200	CEF500113 128176-42071
2GM20/3GM30	REC119305-35151 119305-35151	REC104500-55710 104500-55710	128270-12540	CMC272100-200300 27210-200300	CEF500100GX 104211-42070
2GM20F/3GM30F	REC119305-35151 119305-35151	REC104500-55710 104500-55710	128270-12540	N/A	CEF500129 128296-42070
2GM20-YEU	REC119305-35151 119305-35151	REC104500-55710 104500-55710	128270-12540	CMC272100-200300 27210-200300	JOH09-810B 128990-42200
2GM20F-YEU	REC119305-35151 119305-35151	REC104500-55710 104500-55710	128270-12540	N/A	JOH09-810B 128990-42200
3GTM30-YEU	REC119305-35151 119305-35151	REC104500-55710 104500-55710	128270-12540	CMC272100-200300 27210-200300	JOH09-810B 128990-42200
3GM30F-YEU	REC119305-35151 119305-35151	REC104500-55710 104500-55710	128270-12540	N/A	JOH09-810B 128990-42200
3HM	A/P6034 124550-35110	REC104500-55710 104500-55710	124770-12540	CMC272100-200300 27210-200300	CEF500129 128296-42070
3HMF	A/P6034 124550-35110	REC104500-55710 104500-55710	124770-12540	N/A	CEF500129 128296-42070
3HM35	A/P6034 124550-35110	REC104500-55710 104500-55710	124770-12540	CMC272100-200300 27210-200300	CEF500129 128296-42070
3HM35UF	A/P6034 124550-35110	REC104500-55710 104500-55710	124770-12540	N/A	CEF500129 128296-42070
3JH2E	REC119305-35151 119305-35151	OS1750802 129470-55703	METALICO	N/A	CEF500107T 129470-42532
3JH2-TE	REC119305-35151 119305-35151	OS1750802 129470-55703	REC129470-12330 129470-12330	N/A	CEF500107T 129470-42532
3JH3E-YEU	REC119305-35151 119305-35151	OS1750802 129470-55703	METALICO	N/A	CEF500107T 129670-42531
3JH4E	REC119305-35151 119305-35151	OS1750802 129470-55703	N/A	N/A	CEF500107T 129670-42531
4BY	REC165000-69520 165000-69520	REC120650-55040 120650-55040	N/A	N/A	N/A
4JHE/4JH-TE	REC129150-35153 129150-35153	OS1750802 129470-55703	REC129470-12330 129470-12330	N/A	CEF500107T 129470-42532
4JH-HTE/DTE	REC129150-35153 129150-35153	OS1750802 129470-55703	N/A	N/A	CEF500107T 129470-42532
4JH2E/4JH2-TE	REC129150-35153 129150-35153	OS1750802 129470-55703	REC129470-12330 129470-12330	N/A	CEF500107T 129470-42532
4JH2-HTE/DTE	REC129150-35153 129150-35153	OS1750802 129470-55703	REC129470-12330 129470-12330	N/A	CEF500107T 129470-42532
4JH2-UTE (B)	REC129150-35153 129150-35153	INTFP570F 129574-55711	REC129470-12330 129470-12330	N/A	CEF500107T 129470-42532
4JH3E-YEU	REC129150-35153 129550-35153	OS1750802 129470-55703	METALICO	N/A	CEF500107T 129670-42531
4JH3TE-HTE-DTE	REC129150-35153 129150-35153	INTFP570F 129574-55711	REC129470-12330 129470-12330	N/A	CEF500107T 129670-42531
4JH4E	REC129150-35153 129150-35153	OS1750802 129470-55703	N/A	N/A	CEF500107T 129670-42531
4LH-TE/HTE	REC119005-35100 119005-35100	REC121857-55710 121857-55710	N/A	TEN01317	CEF500106GT 120650-42310
4LH-DTE/STE	REC127695-35150 127695-35150	REC41650-502320 41650-502320	XN199611	TEN01317	CEF500106GT 120650-42310

Las referencias que están en sombreado pedir original

The references that are in shading to ask originally

GUIA MANTENIMIENTO - Guide Maintenance

					
MODELO Model	FILTRO DE ACEITE Oil Filter	FILTRO COMBUSTIBLE Fuel filter	FILTRO DE AIRE Air Filter	ANODO ZINC Zinc Anode	IMPULSOR W.P. Impeller
4LHA-DT(Z)(E)(P)	REC127695-35150 127695-35150	REC41650-502320 41650-502320	REC119195-18880 119195-18880	TEN01316 119574-44150	CEF500106GT 120650-42310
4LHA-HT(Z)(E)(P)	REC127695-35150 127695-35150	REC121857-55710 1211857-55710	REC119195-18880 119195-18880	TEN01316 119574-44150	CEF500106GT 120650-42310
4LHA-ST(Z)(E)(P)	REC127695-35150 127695-35150	REC41650-502320 41650-502320	REC119195-18880 119195-18880	TEN01316 119574-44150	CEF500106GT 120650-42310
6BY	REC165000-69590 165000-69590	REC120650-55040 120650-55040	N/A	N/A	N/A
6CX-ETE	REC127695-35150 127695-35150	REC127695-55630 127695-55630	REC119593-18880 119593-18880	27210-200370	128620-42200
6CX-GTE(2)	REC127695-35150 127695-35150	REC127695-55630 127695-55630	127692-18880	27210-200370	128620-42200
6LP-DT(Z)E/ST(Z)E	REC119770-90620 119770-90620	REC119773-55510 119773-55510	REC119593-18880 119593-18880	TEN01317	CEF500124 119773-42600
6LPA-D/ST(Z)E(P)	REC119770-90620 119770-90620	REC119773-55510 119773-55510	REC119593-18880 119593-18880	TEN01317	CEF500124 119773-42600
6LY-UTE/STE	OS1750115 119593-35100	REC41650-502330 41650-502330	REC119593-18880 119593-18880	TEN01316 119574-44150	CEF500161 119593-42201
6LYA-UTE3/STE	OS1750115 119593-35100	REC41650-502330 41650-502330	REC119593-18880 119593-18880	TEN01316 119574-44150	REC119574-42551 119574-42551
6LY2A-ST(E)(P)	OS1750115 119593-35100	REC41650-502330 41650-502330	REC119593-18880 119593-18880	TEN01303 27210-200200	REC119574-42551 119574-42551
6LY2-ST(E)(P)	REC119593-35400 119593-35400	N/A	N/A	TEN01317	REC119574-42551 119574-42551
6LY3-UTP/STP/ETP	OS1750115 119593-35100	REC41650-502330 41650-502330	REC119593-18880 119593-18880	CMC272100-200300 27210-200300	REC119574-42551 119574-42551
2QM15	REC119305-35151 119305-35151	REC104500-55710 104500-55710	124770-12540	CMC272100-200300 27210-200300	CEF500100GX 104211-42070
2QM	A/P6034 124550-35110	124220-35210	124770-12540	CMC272100-200300 27210-200300	CEF500129 128296-42070
3QM	A/P6034 124550-35110	124220-35210	124770-12540	CMC272100-200300 27210-200300	CEF500170CG 145410-46050
2QM20/3QM30	A/P6034 124550-35110	REC104500-55710 104500-55710	124770-12540	CMC272100-200300 27210-200300	CEF500129 128296-42070
SB8	104271-35130	REC104500-55710 104500-55710	N/A	CMC10421141-300 104211-41300	CEF500100GX 104211-42070
SB12	104271-35130	REC104500-55710 104500-55710	N/A	CMC10421141-300 104211-41300	CEF500100GX 104211-42070
SVE8	104271-35130	104800-55710	N/A	CMC10421141-300 104211-41300	CEF500100GX 104211-42070
SVE12	104271-35130	104800-55710	N/A	CMC10421141-300 104211-41300	CEF500100GX 104211-42070
2YM15	REC119305-35151 119305-35151	REC104500-55710 104500-55710	128270-12540	N/A	JOH09-810B 128990-42200
3YM20(C)	REC119305-35151 119305-35151	REC104500-55710 104500-55710	128270-12540	N/A	JOH09-810B 128990-42200
3YM30(C)	REC119305-35151 119305-35151	REC104500-55710 104500-55710	128270-12540	N/A	JOH09-810B 128990-42200
YSB8	104271-35130	REC104500-55710 104500-55710	N/A	CMC272100-200300 27210-200300	CEF500100GX 104211-42070
YSB12	104271-35130	REC104500-55710 104500-55710	N/A	CMC272100-200300 27210-200300	CEF500100GX 104211-42070
YSE8	104271-35130	104300-55790	N/A	CMC10421141-300 104211-41300	CEF500100GX 104211-42070
YSE12	104271-35130	104300-55790	N/A	CMC10421141-300 104211-41300	CEF500100GX 104211-42070
YSM87YSM12	104271-35130	REC104500-55710 104500-55710	N/A	CMC272100-200300 27210-200300	CEF500100GX 104211-42070

Las referencias que están en sombreado pedir original

The references that are in shading to ask originally

SOPORTES MOTOR - Engine mounts

**SOPORTE ELASTICO
ENGINE MOUNT**

GOLDENSHIP

Tipo «Yanmar»

SopORTE elástico para motor.
Fabricado en metal y neopreno vulcanizado.

*Flexible engine mount
manufactured in metal and
vulcanized neoprene.*

Ref. Carga máx./Max. load

GS38120	40 kgs / 88 lbs
GS38107	75 kgs / 165 lbs
GS38108	100 kgs / 220 lbs
GS38121	150 kgs / 330 lbs

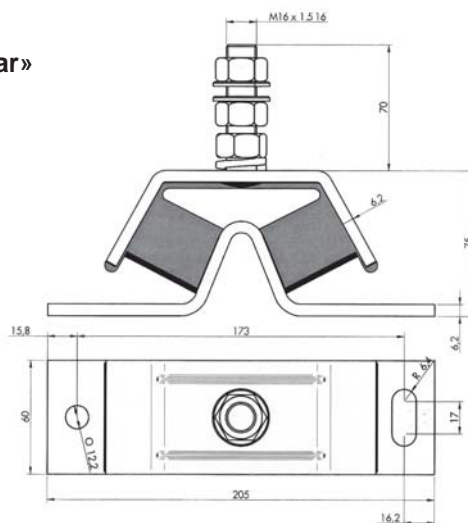

ANODOS DE ZINC Y ALUMINIO - Zinc & Aluminum Anodes

CM19642002652Z
ANODO ZINC COLA VELERO
Saildrive anode
R.O.: 196420-02652



CM19642002652A
ALUMINIO / Aluminum

CM19644002660KITZ
ANODO ZINC COLA VELERO
SD20, SD30, SD31, SD40 & SD50
Saildrive zinc anode
R.O.: 196440-02660



CM19644002660KITA
ALUMINIO / Aluminum

CMSGMA015
ANODO
Para motores 70-85 HP
Zinc anode
For engines 70-85HP

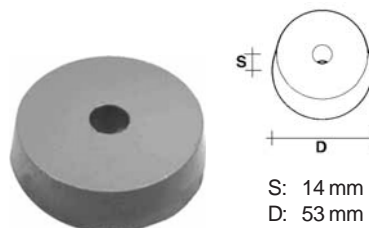

CMSGYN261
ANODO ZINC
Placa motor
Zinc anode - engine plate

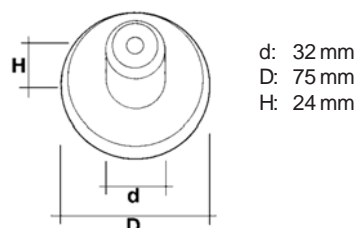

CMSGYN068
ANODO CON ROSCA DE ACERO M8
Para motores 8-10HP
Zinc anode w/thread & steel core M8
For engines 8-10HP
R.O.: 104211-41300

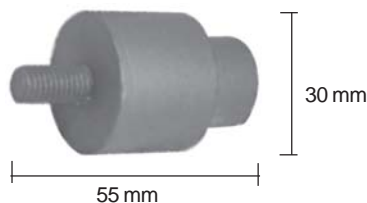

TEN01303
ANODO CON ROSCA DE ACERO M8
Zinc anode w/thread & steel core M8
R.O.: 27210-200200



CMSGYN069
ANODO CON ROSCA DE ACERO M8
Zinc anode w/thread & steel core M8



CMSGYN224
ANODO CON ROSCA DE ACERO M8
Zinc anode w/thread & steel core M8
R.O.: 27210-20300



HÉLICES ALUMINIO 3 Palas - 3 Blades Aluminum Propellers

Colas Yanmar Sterndrive

	B	D	P	Ro	Aluminio - Aluminum	
					Amita 3	Amita 3-E Plus
SZ110, 111, 160, 161	3	15.5	15	L	SOL8712-150-15	
	3	14.8	17	L	SOL8712-148-17	
Cubo standard 9,5 mm	3	14.5	19	L	SOL8712-145-19	
Standard Hub 9,5 mm	3	14.3	21	L	SOL8712-143-21	

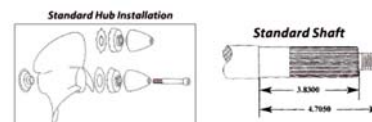

Colas Yanmar Sterndrive

	B	D	P	Ro	Aluminio - Aluminum	
					Amita 3	Amita 3-E Plus
SZ200, 251, 301	3	15	15	L	SOL8812-150-15	
	3	14.8	17	L	SOL8812-148-17	
Cubo largo 11,5 mm	3	14.5	19	L	SOL8812-145-19	
Long Hub 11,5 mm	3	14.3	21	L	SOL8812-143-21	
	3	14.2	23	L	SOL8812-142-23	
	3	15.8	15	L		SOL8812-158-15
	3	15.5	17	L		SOL8812-155-17
	3	15.3	19	L		SOL8812-153-19
	3	15.3	21	L		SOL8812-153-21

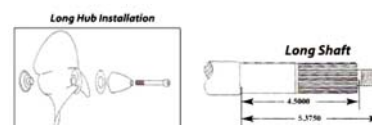

HÉLICES B3 - B3 propellers

HELICES DE ACERO INOXIDABLE Para Colas YANMAR ZT350 y ZT370

Hélices delanteras de 4 palas.
Hélices traseras de 3 palas.
19 estrías y escape a través de la hélice.

SOLAS
B3



STAINLESS STEEL PROPELLERS For YANMAR sterndrives ZT350 & ZT370

Front propellers with 4 blades.
Rear propellers with 3 blades.
19 Tooth Spline and Thru hub exhaust.

Ref.Original O.E.M. nr.	Posición Position	Palas Blades	Diámetro Diameter	Paso Pitch	Rotación Rotation	Ref. Solas
196350-09400	Del / Front	4	16"	20	Izq. / Left	SOL1654-160-20
196350-09400	Tras/ Rear	3	14 3/8"	20	Der / Right	SOL1651-144-20
-----	Del / Front	4	16"	21	Izq. / Left	SOL1654-160-21
-----	Tras/ Rear	3	14 3/8"	21	Der / Right	SOL1651-144-21
196350-09420	Del / Front	4	15 3/4"	22	Izq. / Left	SOL1654-158-22
196350-09720	Tras/ Rear	3	14 1/4"	22	Der / Right	SOL1651-143-22
-----	Del / Front	4	15 3/4"	23	Izq. / Left	SOL1654-158-23
-----	Tras/ Rear	3	14 1/4"	23	Der / Right	SOL1651-143-23
196350-09440	Del / Front	4	15 1/2"	24	Izq. / Left	SOL1654-155-24
196350-09740	Tras/ Rear	3	14 "	24	Der / Right	SOL1651-140-24
-----	Del / Front	4	15 1/2"	25	Izq. / Left	SOL1654-155-25
-----	Tras/ Rear	3	14"	25	Der / Right	SOL1651-140-25
196350-09460	Del / Front	4	15 1/2"	26	Izq. / Left	SOL1654-155-26
196350-09760	Tras/ Rear	3	14"	26	Der / Right	SOL1651-140-26
-----	Del / Front	4	15"	27	Izq. / Left	SOL1654-150-27
-----	Tras/ Rear	3	13 3/4"	27	Der / Right	SOL1651-138-27
196350-09480	Del / Front	4	15"	28	Izq. / Left	SOL1654-150-28
196350-09780	Tras/ Rear	3	13 3/4"	28	Der / Right	SOL1651-138-28